

Long Sensing Distance Type

Long sensing distance proximity sensor

■ Features

- Longer sensing distance up to 25mm
- Improved the noise resistance with dedicated IC
- Reverse power polarity, surge, overcurrent protection
- Long life cycle and reliable
- Red LED status indication
- IP67 rated waterproof structure (IEC standard)
- Replacer for micro switches and limit switches



⚠ Please read "Caution for your safety" in operation manual before using.



■ Specifications

● DC 3-wire type

Model	PRD12-4DN PRD12-4DP PRD12-4DN2 PRD12-4DP2 PRDS12-4DN PRDS12-4DP PRDS12-4DN2 PRDS12-4DP2 PRDW12-4DN PRDW12-4DP PRDW12-4DN2 PRDW12-4DP2	PRD12-8DN PRD12-8DP PRD12-8DN2 PRD12-8DP2 PRDS12-8DN PRDS12-8DP PRDS12-8DN2 PRDS12-8DP2 PRDW12-8DN PRDW12-8DP PRDW12-8DN2 PRDW12-8DP2	PRD18-7DN PRD18-7DP PRD18-7DN2 PRD18-7DP2 PRDL18-7DN PRDL18-7DP PRDL18-7DN2 PRDL18-7DP2 PRDW18-7DN PRDW18-7DP PRDW18-7DN2 PRDW18-7DP2 PRDWL18-7DN PRDWL18-7DP PRDWL18-7DN2 PRDWL18-7DP2	PRD18-14DN PRD18-14DP PRD18-14DN2 PRD18-14DP2 PRDL18-14DN PRDL18-14DP PRDL18-14DN2 PRDL18-14DP2 PRDW18-14DN PRDW18-14DP PRDW18-14DN2 PRDW18-14DP2 PRDWL18-14DN PRDWL18-14DP PRDWL18-14DN2 PRDWL18-14DP2
Sensing distance	4mm ±10%	8mm ±10%	7mm ±10%	14mm ±10%
Hysteresis	Max. 10% of sensing distance			
Standard sensing target	12×12×1mm (Iron)	25×25×1mm (Iron)	20×20×1mm (Iron)	40×40×1mm (Iron)
Setting distance	0 to 2.8mm	0 to 5.6mm	0 to 4.9mm	0 to 9.8mm
Power supply (Operating voltage)	12-24VDC (10-30VDC)			
Current consumption	Max. 10mA			
Response frequency(*1)	500Hz	400Hz	300Hz	200Hz
Residual voltage	Max. 1.5V			
Affection by Temp.	Within ±10% max. of sensing distance at +20°C in temperature range of -25 to +70°C			
Control output	200mA			
Insulation resistance	Min. 50MΩ (at 500VDC mega)			
Dielectric strength	1500VAC 50/60Hz for 1minute			
Vibration	1mm amplitude at frequency of 10 ~ 55Hz in each of X, Y, Z directions for 2 hours			
Shock	500m/s ² (50G) X, Y, Z directions for 3 times			
Indicator	Operating indicator (Red LED)			
Ambient temperature	-25 ~ +70°C (non-freezing condition)			
Storage temperature	-30 ~ +80°C (non-freezing condition)			
Ambient humidity	35 ~ 95%RH			
Protection circuit	Surge, Reverse poser polarity, Overcurrent protection circuit			
Protection	IP67 (IEC Standard)			
Approval	CE			
Unit weight	PRD:Approx.74g PRDS:Approx.72g PRDW:Approx.44g	PRD:Approx.72g PRDS:Approx.70g PRDW:Approx.42g	PRD:Approx.115g PRDL :Approx.159g PRDW:Approx.80g PRDWL:Approx.110g	PRD:Approx.110g PRDL:Approx.140g PRDW:Approx.75g PRDWL:Approx.105g

※(*1) The response frequency is the average value. The standard sensing target is used and the width is set as 2 times of the standard sensing target, 1/2 of the sensing distance for the distance.

(A) Counter

(B) Timer

(C) Temp. controller

(D) Power controller

(E) Panel meter

(F) Tacho/Speed/Pulse meter

(G) Display unit

(H) Sensor controller

(I) Switching power supply

(J) Proximity sensor

(K) Photo electric sensor

(L) Pressure sensor

(M) Rotary encoder

(N) Stepping motor & Driver & Controller

(O) Graphic panel

(P) Production stoppage models & replacement

PRD Series

■ Dimensions

(Unit:mm)

●PRD12-4D□

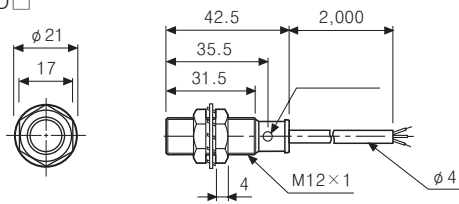

●PRDS12-4D□

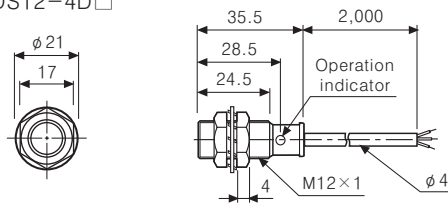

●PRD12-8D□

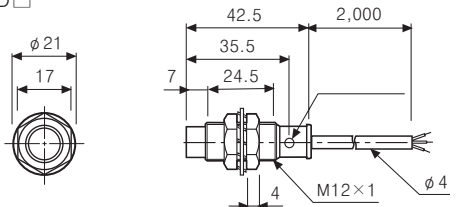

●PRDS12-8D□

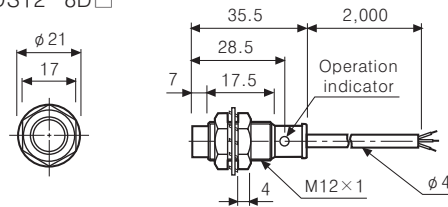

●PRD18-7D□

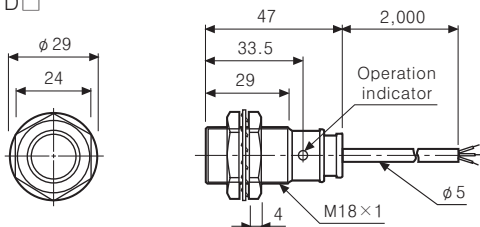

●PRDL18-7D□

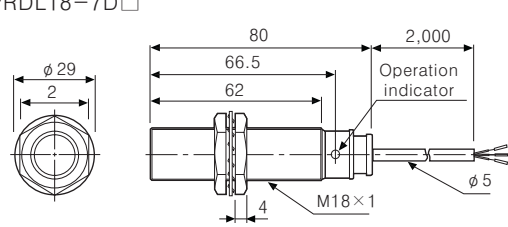

●PRD18-14D□

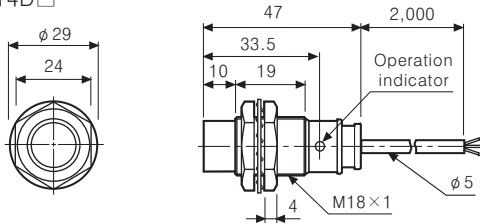

●PRDL18-14D□

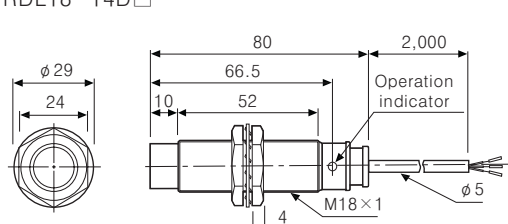

●PRDW12-4D□

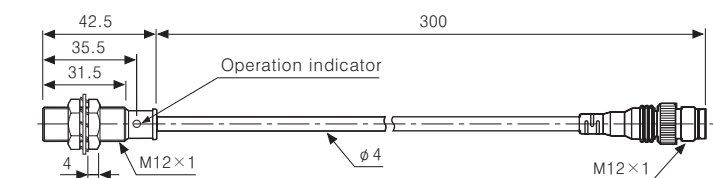

●PRDW12-8D□

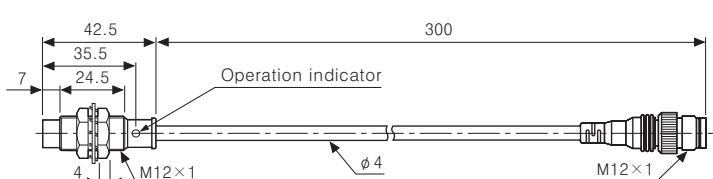
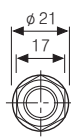

●PRDW18-7D□

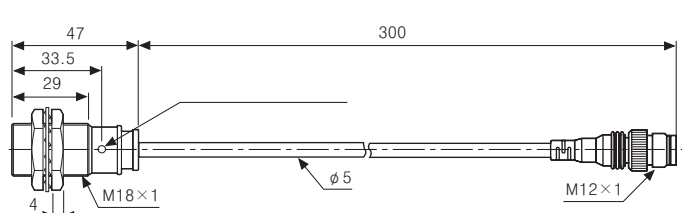
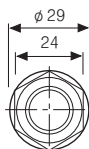
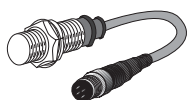

●PRDW18-14D□

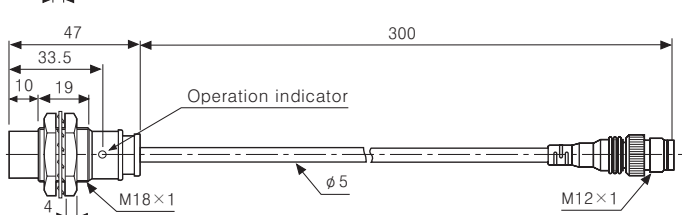
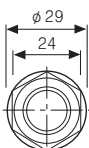
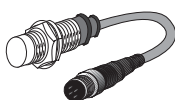

Long Sensing Distance Type

Dimensions

(Unit:mm)

●PRDWL18-7D□

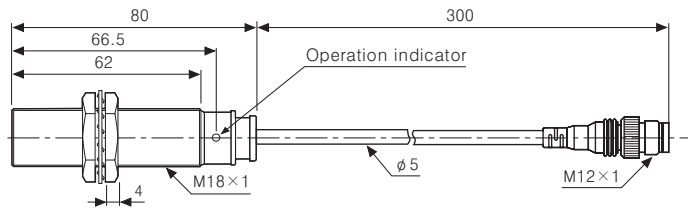
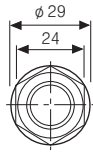
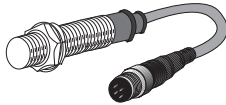

●PRDWL18-14D□

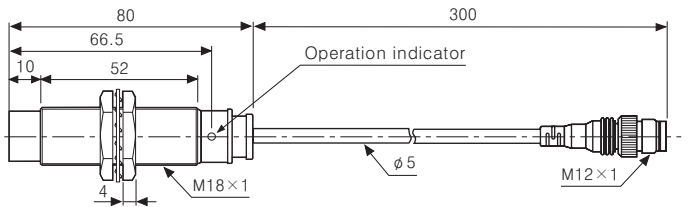
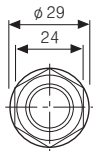
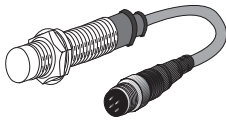

Control output diagram

◎DC 3-wire type

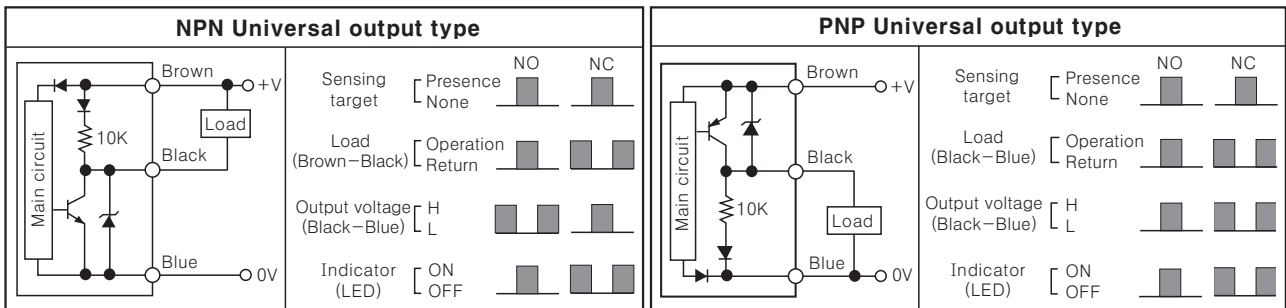

Connections

◎DC 3-wire type

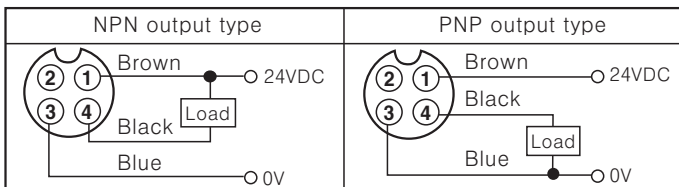

※Please fasten the cleat of connector not to shown the thread. (0.39~0.49N·m)

※Please fasten the vibration part with Teflon tape.

※See J-48 for IEC standard connector cables and specifications.

Proper usage

◎Mutual-interference

When several proximity sensors are mounted closely, malfunction of sensor may be caused due to mutual interference. Therefore, be sure to provide a minimum distance between the two sensors, as below charts.

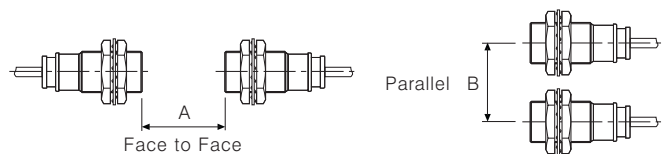

◎Influence by surrounding metals

When sensors are mounted on metallic panel, you must prevent the sensors from being affected by any metallic object except target. Therefore, be sure to provide a minimum distance as below chart.

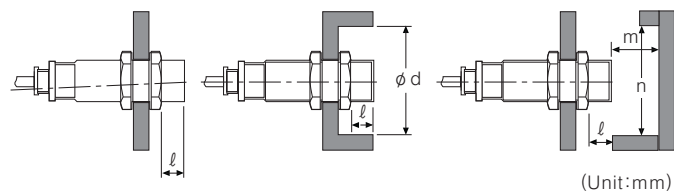

(Unit:mm)

Item \ Model	PRD□12-4D□	PRD□12-8D□	PRD□18-7D□ PRDW□18-7D□	PRD□18-14D□ PRDW□18-14D□
A	24	48	42	84
B	24	36	36	54
l	0	11	0	14
φd	12	36	18	54
m	12	24	21	42
n	18	36	27	54

(A) Counter

(B) Timer

(C) Temp. controller

(D) Power controller

(E) Panel meter

(F) Tacho/Speed/Pulse meter

(G) Display unit

(H) Sensor controller

(I) Switching power supply

(J) Proximity sensor

(K) Photo electric sensor

(L) Pressure sensor

(M) Rotary encoder

(N) Stepping motor & Driver & Controller

(O) Graphic panel

(P) Production stoppage models & replacement